

## Pressure transmitter (2 wire) / switch for continuous or On/Off Control



- Indication, monitoring, transmitting and continuous or On/Off control in one device
- Output signal 4...20 mA, 2-wire for continuous control
- Transistor or relay outputs for On/Off control or alarm function

Type 8311 can be combined with...



**Type 2702 (8630)**

Control valve with TopControl



**Type 2712 (1067)**

Control valve with SideControl

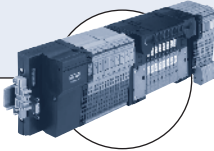

**Type 8644-P AirLINE**

Valve island with electronic I/O



**Type 8624-2**

PI pressure controller

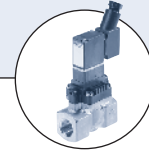

**Type 6213**

Solenoid valve

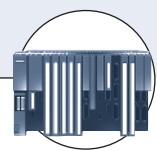

**PLC**

This intelligent mini transmitter/switch with an extra-large display is specially designed to switch alarms and to establish a monitoring system or an On/Off control loop. The switching points can be programmed with the three-key keypad under the display. In addition, the process value can be transmitted to the PLC (4-20 mA). The connection to the process in the piping is made using standard fittings.

### General data

#### Materials

Housing, cover	PC, +20% glass fibre
Front panel folio / Screws	Polyester / Stainless steel
Cable plug/Multipin	PA
Materials wetted parts	Stainless steel
Seal	FKM (EPDM option)

#### Sensor element

Ceramic cell (Al<sub>2</sub>O<sub>3</sub>)

#### Service life of pressure cell

Min. 100 million cycles

#### Electrical connections

Cable plug: EN 175301-803  
Multipin<sup>1)</sup>: M12, 5-pin

#### Voltage supply cable

164 ft., shielded, 0.14 up to 0.5 mm<sup>2</sup> max.

### Complete device data (pipe + electronic module)

#### Pipe diameter

Any pipe with sensor connection 1/2"  
(1 1/2" or 2" Tri-Clamp® available upon request)

#### Measuring range

up to 29, 73, 145, 290 or 725 PSI

#### Medium temperature

-4°F up to 212°F (-20°C up to 100°C)  
(212°F for an ambient temperature of max. 104°F)

#### Typical accuracy

##### Transmitter 2-wire version

for 0°C < T < 70°C  
for -20°C < T < 0°C  
for 70°C < T < 100°C

≤ ±1% of F.S.\*  
≤ ±1% ± 0.03% of F.S.\* / °C  
≤ ±1% ± 0.03% of F.S.\* / °C

##### Switch version

≤ ±1.5% of F.S.\*

#### Typical repeatability

Transmitter 2-wire version  
Switch version

≤ ±0.06%  
≤ ±0.25%

\* F.S. = Full scale

1) Has to be ordered separately

Electrical data	
<b>Power supply</b>	12-30 V DC , filtered and regulated
<b>Overvoltage protection</b>	Yes, for power supply and for transistor outputs
<b>Current consumption</b> Transmitter 2-wire version Switch version	< 30 mA (+700 mA max. per transistor output used) < 750 mA (with load - PNP output configuration) < 80 mA (with load - Relay version)
<b>Output</b> Transmitter 2-wire version Transistor (programmable)  Process value  Switch version Transistor (programmable)  Optional relay (programmable)	open collector, 2 NPN or 2 PNP, 700 mA max., NPN: [(V+) minus 0.5 VDC] - 0 VDC PNP: 0.5 VDC - (V+) protected against short circuit 4-20 mA, Loop resistance: 800 Ω at 30 V DC, 550 Ω at 24 V DC, 300 Ω at 18 V DC (For more details, see instruction manual)  open collector, NPN / PNP, 700 mA max., NPN: 0.2 - 30 VDC ; PNP: (V+) protected against short circuit 3 A / 250 V AC or 3 A / 30 V DC (relay)
<b>Reversed polarity of DC</b>	Protected (for power supply and all outputs)
Environment	
<b>Ambient temperature</b>	-4°F up to 140°F (-20 up to 60°C) (104°F max. if the medium temperature near 212°F)
<b>Storage temperature</b>	-20 up to 80°C
<b>Relative humidity</b>	≤ 80%, non condensated
Standards and approvals	
<b>Protection class</b>	IP65 with connector plug-in
<b>Standard</b> EMC Security Vibration Shock	EN 50081-1, 50082-2, 61000-6-2 EN 61010-1 EN 60068-2-6 EN 60068-2-27

## Main features

### Display

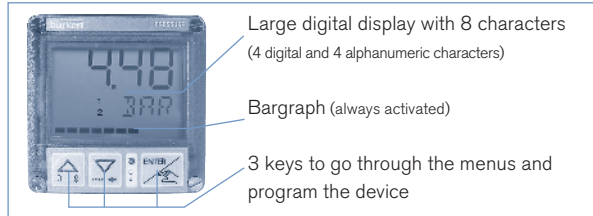

### Software main features

#### Switch and transmitter

- International measuring units
- 10-segment bargraph
- Teach-In for an improved accuracy
- Simulation mode to test the programming of the switching points, in dry conditions

#### Transmitter

- Simulation mode to test the programming of 4-20 mA output, in dry conditions
- Display and storage of min/max value
- Protection by code against unauthorized access
- Reset function to default parameters
- Alarm output programmable as internal default alarm

### Working mode of alarm outputs

- 2 switching modes for the output, either hysteresis or window, inverted or not

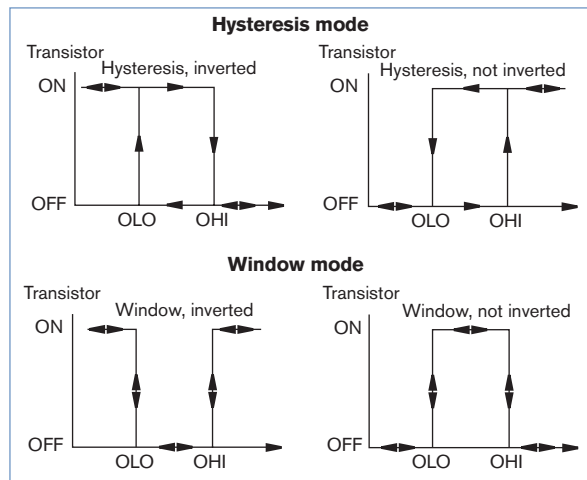

- Programmable delay before switching
- Output available as transistor NPN or PNP, relay (up to 3A)
- Outputs can be programmed as internal default alarm.

Dimensions

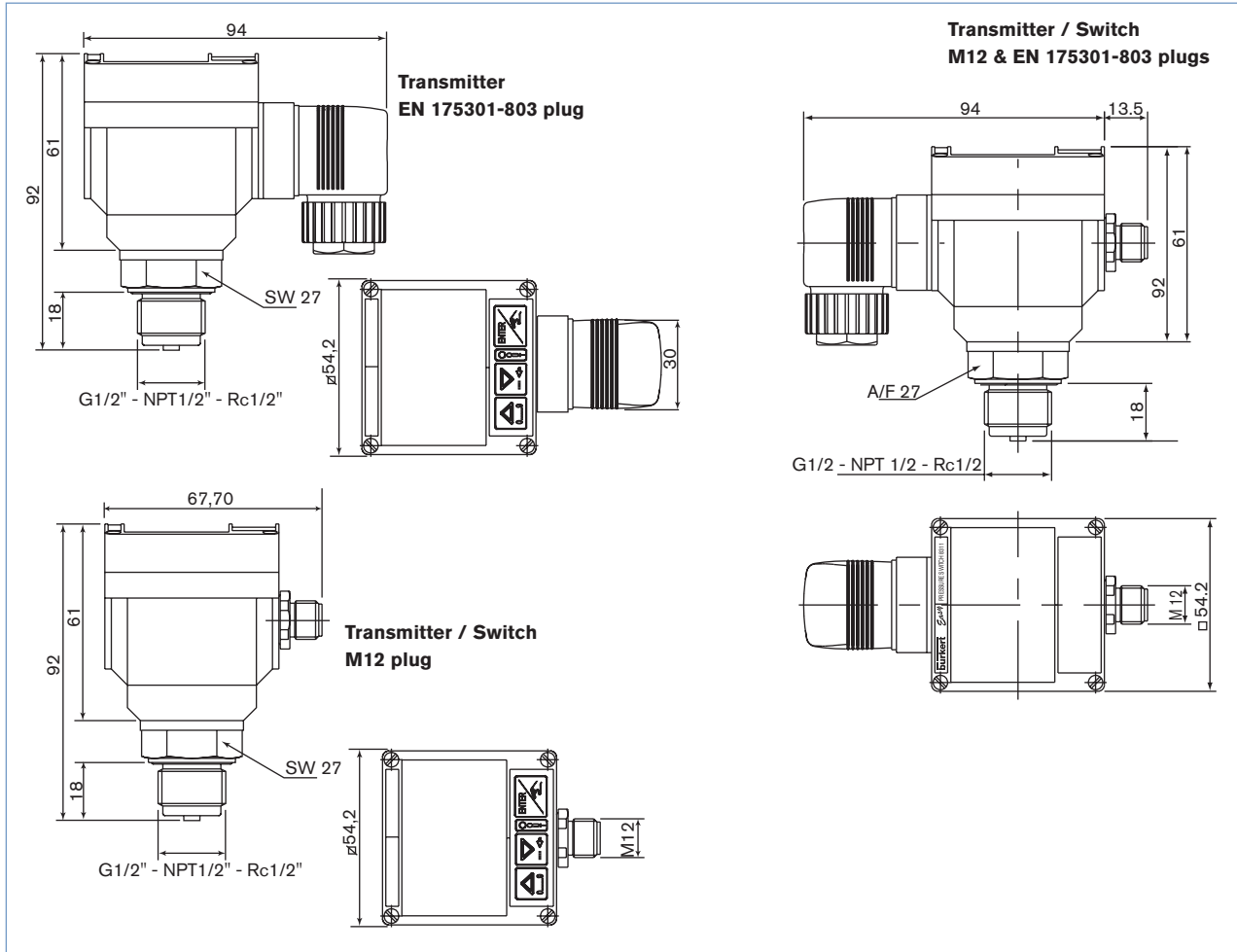

Ordering chart for Type 8311 (other versions on request)

Transmitter version

Nominal pressure range [PSI]	Pressure max. [PSI]	Burst pressure [PSI]	Power supply	Output signal	Electrical connection**	Item no. sensor connection G 1/2"	Item no. sensor connection NPT 1/2"***	Item no. sensor connection Rc 1/2"
0 - 14.5	29	58	12 - 30 VDC	4-20 mA + 2 NPN or 2 PNP <sup>1)</sup>	M12 plug 5 pins	557 934	557 935	on request
				4-20 mA	Cable plug Type 2508*	550 350	557 937	on request
0 - 29	58	102	12 - 30 VDC	4-20 mA + 2 NPN or 2 PNP <sup>1)</sup>	M12 plug 5 pins	444 507	444 762	551 739
				4-20 mA	Cable plug Type 2508*	444 635	444 640	444 768
0 - 73	145	174	12 - 30 VDC	4-20 mA + 2 NPN or 2 PNP <sup>1)</sup>	M12 plug 5 pins	444 506	444 763	551 740
				4-20 mA	Cable plug Type 2508*	444 636	444 641	444 769
0 - 145	290	363	12 - 30 VDC	4-20 mA + 2 NPN or 2 PNP <sup>1)</sup>	M12 plug 5 pins	444 503	444 764	551 741
				4-20 mA	Cable plug Type 2508*	550 338	444 642	444 770
0 - 290	580	725	12 - 30 VDC	4-20 mA + 2 NPN or 2 PNP <sup>1)</sup>	M12 plug 5 pins	444 504	444 765	551 742
				4-20 mA	Cable plug Type 2508*	550 339	444 760	551 737
0 - 725	1450	1740	12 - 30 VDC	4-20 mA + 2 NPN or 2 PNP <sup>1)</sup>	M12 plug 5 pins	444 505	444 767	551 743
				4-20 mA	Cable plug Type 2508*	444 637	444 761	551 738

<sup>1)</sup> PNP standard, can be change in NPN with jumpers on electronic board

\* Acc. EN175301-803 Europe / Asia (G / Rc) : with cable gland  
USA / CDN (NPT) : with reduction NPT1/2

\*\* Electrical plugs must be ordered separately (see page 4)

Ordering chart for Type 8311 (other versions on request)

Switch version

Nominal pressure range [PSI]	Pressure max. [PSI]	Burst pressure [PSI]	Power supply	Output signal	Electrical connection	Item no. sensor connection G 1/2"	Item no. sensor connection NPT 1/2"	Item no. sensor connection Rc 1/2"
0 - 29	58	102	12 - 30 VDC	NPN / PNP	M12 plug 5 pins	439 908	US08565	439 912
				Relay	M12- 5 pins + Cable plug Type 2508*	439 911	US08562	439 915
0 - 73	145	174	12 - 30 VDC	NPN / PNP	M12 plug 5 pins	439 920	US08558	439 924
				Relay	M12- 5 pins + Cable plug Type 2508*	439 923	US08555	439 927
0 - 145	290	363	12 - 30 VDC	NPN / PNP	M12 plug 5 pins	439 932	US08551	439 936
				Relay	M12- 5 pins + Cable plug Type 2508*	439 935	US08548	439 939
0 - 290	580	725	12 - 30 VDC	NPN / PNP	M12 plug 5 pins	439 944	US08544	439 948
				Relay	M12- 5 pins + Cable plug Type 2508*	439 947	US08541	439 951
0 - 725	1450	1740	12 - 30 VDC	NPN / PNP	M12 plug 5 pins	439 956	US08537	439 960
				Relay	M12- 5 pins + Cable plug Type 2508*	439 959	US08534	439 963

\* Acc. EN175301-803 Europe / Asia (G / Rc) : with cable gland  
 USA / CDN (NPT) : with NPT1/2 reduction

\*\* Includes electrical plugs

Ordering chart for accessories (to be ordered separately)

Description	Item no.
5 pin M12 female cable connector with plastic threaded locking ring	917 116
5 pin M12 female connector moulded on cable (2 m, shielded)	438 680
Cable plug EN 175301-803 with cable gland (Type 2508)	438 811
Cable plug EN 175301-803 with NPT1/2" reduction without cable gland (Type 2509)	162 673

Interconnection possibilities with other Bürkert products

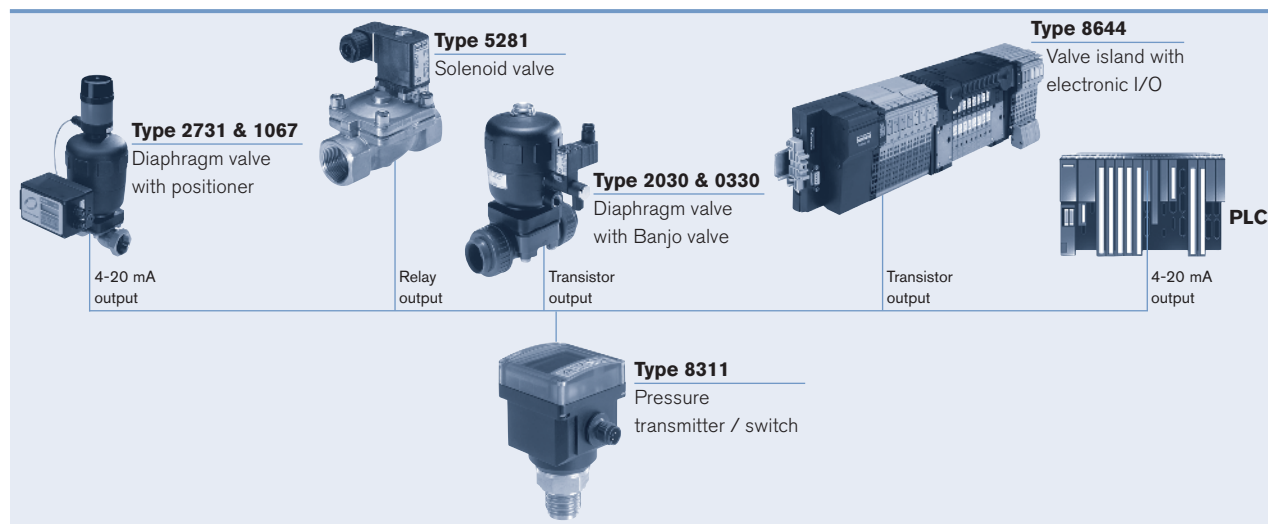

In case of special application conditions, please consult for advice.

We reserve the right to make technical changes without notice.

0701/3\_US-en