

## Ultrasonic level measuring device



- For level measurement up to 8 m
- 4...20 mA/HART - 2 wires
- Suitable for solids
- ATEX certification 

Type 8177 can be combined with...



**Type 8611**  
Universal process  
controller eCONTROL

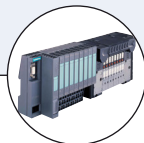

**Type 8644**  
Valve islands

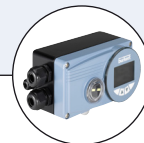

**Type 8793**  
Process controller



**Type 8802**  
ELEMENT control  
valve system



**PLC**

The type 8177 is a non-contact ultrasonic level measuring device, designed for continuous level measurement in open or closed vessels.



The unit is suitable for liquids, but also for solids, in virtually all industries, particularly in water and waste water management.

### General data

<b>Materials</b>	
Housing	PBT, Stainless steel 316L (1.4404)
Cover	PC
Seal ring	EPDM
Ground terminal	Stainless steel 316Ti/316L (1.4571/1.4435)
Wetted parts	
Process connection, transducer	PVDF
Process seal	EPDM
<b>Display</b>	LCD in full dot matrix
<b>Process connection</b>	Thread G 2" or NPT 2"
<b>Max. torque mounting boss</b>	25 Nm
<b>Electrical connection</b>	Cable glands M20 x 1.5
<b>Measuring value</b>	Distance between lower edge of the transducer and product surface
<b>Dead zone</b>	0.4 m
<b>Measuring range</b>	0.4...8 m (for liquids) 0.4...3.5 m (for solids)
<b>Process temperature</b>	-40...+80 °C (-40...176 °F)
<b>Vessel pressure</b>	-0.2...2 bar (-2.9...29.02 PSI) (-20...200 kPa)
<b>Vibration resistance</b>	Mechanical vibrations with 4 g and 5...100 Hz
<b>Temperature coefficient</b>	0.06 %/10K (Average temperature coefficient of the zero signal - temperature error)
<b>Resolution</b>	Max. 1 mm
<b>Frequency</b>	55 kHz
<b>Interval</b>	>2 s (dependent on the parameter adjustment)
<b>Beam angle at 3 dB</b>	11°
<b>Adjustment time<sup>1)</sup></b>	>3 s (dependent on the parameter adjustment)
<b>Measurement deviation<sup>2)</sup></b>	<0.2 % or ±4 mm (see diagram)

<sup>1)</sup> Time to output the correct level (with max. 10 % deviation) after a sudden level change.

<sup>2)</sup> = "measurement bias" as defined in the standard JCGM 200:2012

Electrical data	
Operating voltage	14...36 V DC or 14...30 V DC (Ex ia instrument)
Permissible residual ripple	< 100 Hz: U <sub>ss</sub> < 1 V 100 Hz... 10 kHz: U <sub>ss</sub> < 10 mV
Output signal	4...20 mA/HART
Resolution	1.6 µA
Fault signal	Current output unchanged; 20.5 mA; 22 mA < 3.6 mA (adjustable)
Current limitation	22 mA
Load	See load diagram
Damping (63 % of the input variable)	0...999 s, adjustable
Environment	
Ambient temperature with display, adjustment elements	-20...+70 °C (-4...+158 °F) (operation and storage)
Relative humidity	Max. 75 % (operation), max. 85 % (storage); without condensation
Standards, directives and certifications	
Protection	IP66/IP67 with M20 × 1.5 gland mounted and tight- ened
Overvoltage category	III
Protection class	II
Standards and directives <b>CE</b>	The applied standards, which verify conformity with the EU Directives, can be found on the EU Type Ex- amination Certificate and/or the EU Declaration of conformity (if applicable) NE 21; NE 43
NAMUR	NE 21; NE 43
Certification	ATEX <sup>3)</sup> : EN 50014; EN 50020; EN 50284
Specifications Ex	
 - Protection	Categories 1/2G or 2G
 - Certification	EEx ia IIC T6
Conformity specifications <sup>3)</sup>	
Operating voltage U <sub>i</sub>	30 V
Short circuit rating I <sub>i</sub>	131 mA
Power limitation P <sub>i</sub>	983 mW
Ambient temperature	-20...+41 °C (-4...+105.8 °F) (dependent on categories)
Internal capacity C <sub>i</sub>	negligible
Internal inductivity L <sub>i</sub>	negligible

<sup>3)</sup> homologation certificate PTB 07 ATEX 2003X

### Measurement deviation diagram

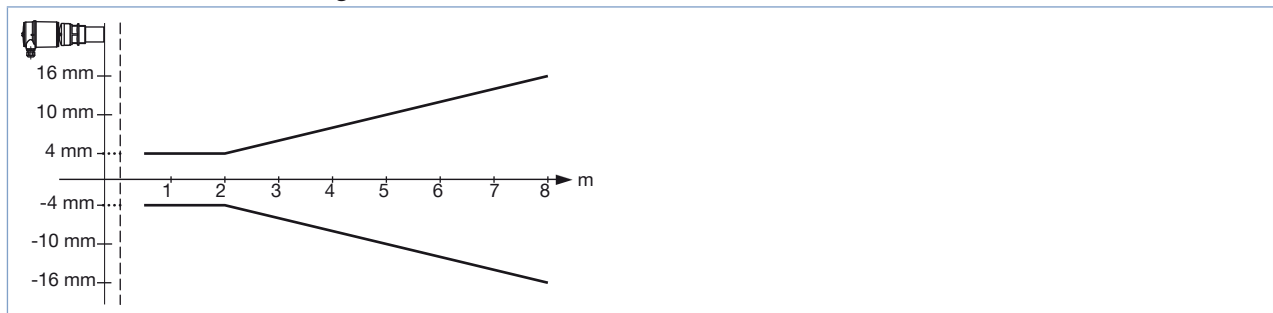

### Load diagram

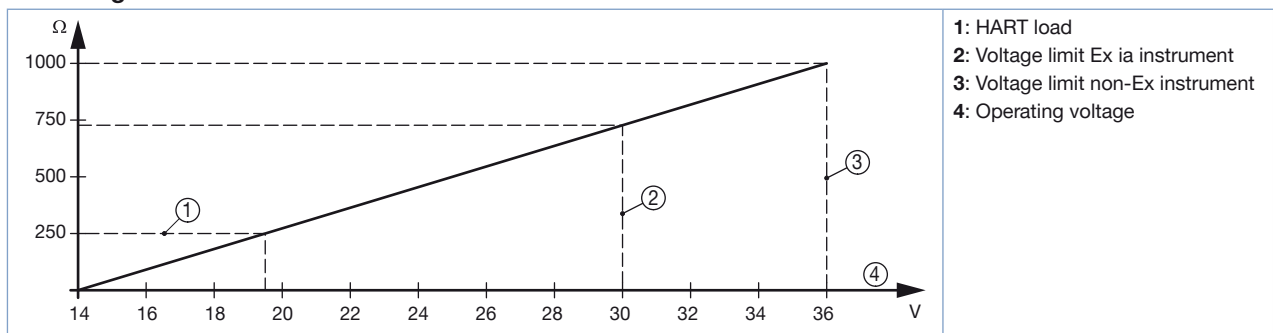

## Target applications

### ■ Continuous level measuring for fluids and solids

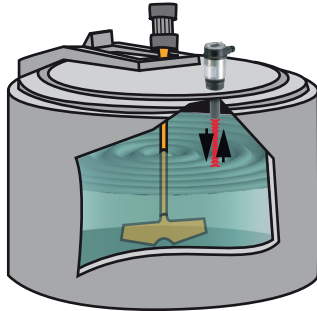

### ■ Distance measuring



### ■ Open basins

A typical application for the 8177 ultrasonic measuring device is level measurement in open basins. Products such as rain water or sewage water, i.e. with impurities. Here is where the advantages of non-contact measurement with the 8177 come into their own: simple and maintenance-free. The degree of pollution of water or an accumulation of mud in the basin is not important, because the 8177 measures the surface.

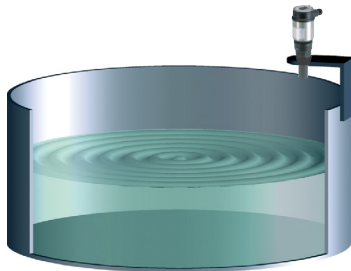

### ■ Sludge container

In sewage treatment plants, the accumulated sludge is dewatered and transported via conveyor belts to containers. The 8177 measuring device measures the filling of the container. An empty container can thus be readied in good time before the max. level is reached.

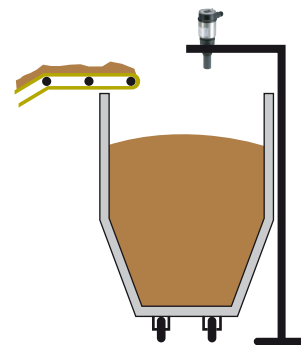

## Principle of operation

The transducer of the ultrasonic measuring device emits short ultrasonic pulses, at 55 kHz to the measured product. These pulses are reflected by the medium surface and received by the transducer as echoes. The running time of the ultrasonic pulses from emission to reception is proportional to the distance and hence to the level. An integrated temperature sensor detects the temperature in the vessel and compensates the influence of temperature on the signal running time. The determined level is converted into an output signal and transmitted as a measured value.

The measuring device is adjusted with the display/configuration module. The entered parameters are generally saved in the measuring device, Type 8177. Optionally, parameters may also be uploaded and downloaded with the display/configuration module.

► Set up with display/configuration module:

The display/configuration module can be inserted into the measuring device and removed again at any time. It is not necessary to interrupt the power supply. The measuring device is adjusted via the four keys of the display/configuration module.

### Display/configuration module

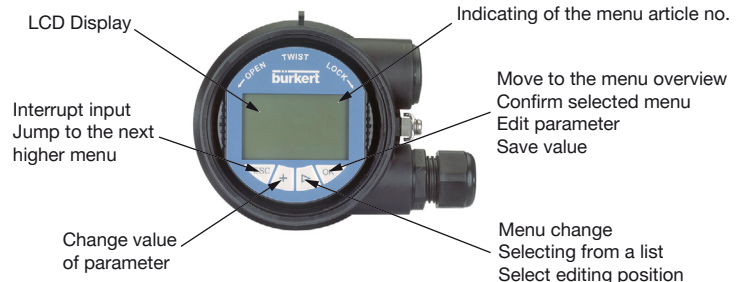

## Dimensions [mm]

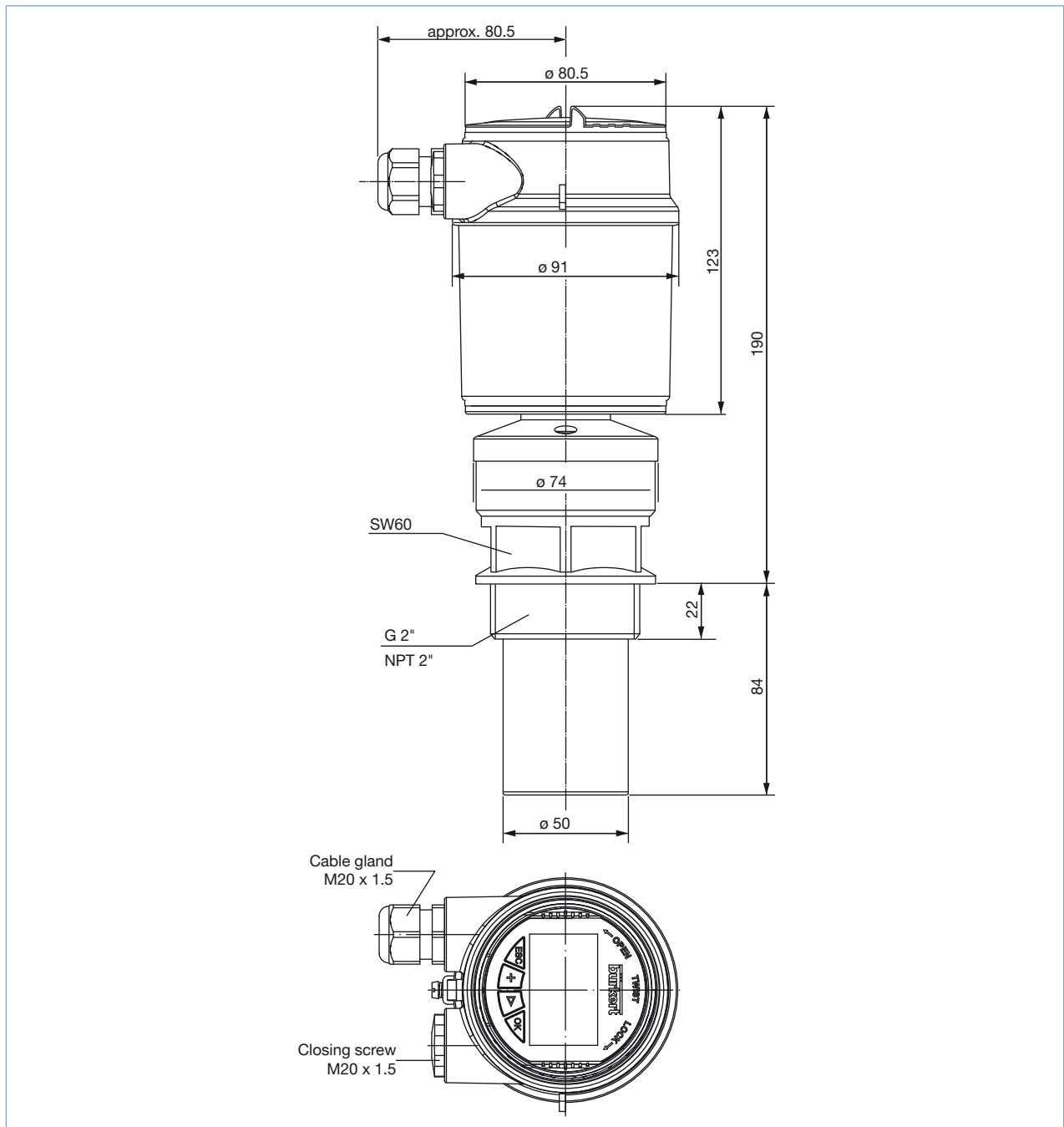

## Ordering chart for compact 8177 measuring device

Specification	Operating voltage	Output	Electrical connection	Article no. (with display / configuration module)	Article no. (without display / configuration module)
G 2" mounting thread	14...36 V DC	4...20 mA/HART (2 wires)	Cable gland M20 × 1.5	558224	559243
NPT 2" mounting thread	14...36 V DC	4...20 mA/HART (2 wires)	Cable gland M20 × 1.5	558225	559244
Ex version – ATEX certification G 2" mounting thread	14...30 V DC	4...20 mA/HART (2 wires)	Cable gland M20 × 1.5	558226	559245

## Ordering chart -accessories for 8177 measuring device (has to be ordered separately)

Specification	Article no.
Set with 2 reductions M20 × 1.5/NPT½" +2 neoprene flat seals for cable gland +2 screw-plugs M20 × 1.5	551782
Set with a display/configuration module, a transparent cover and a seal ring	559279
Set with a transparent cover and a seal ring	561006

## Interconnection possibilities with other Bürkert devices

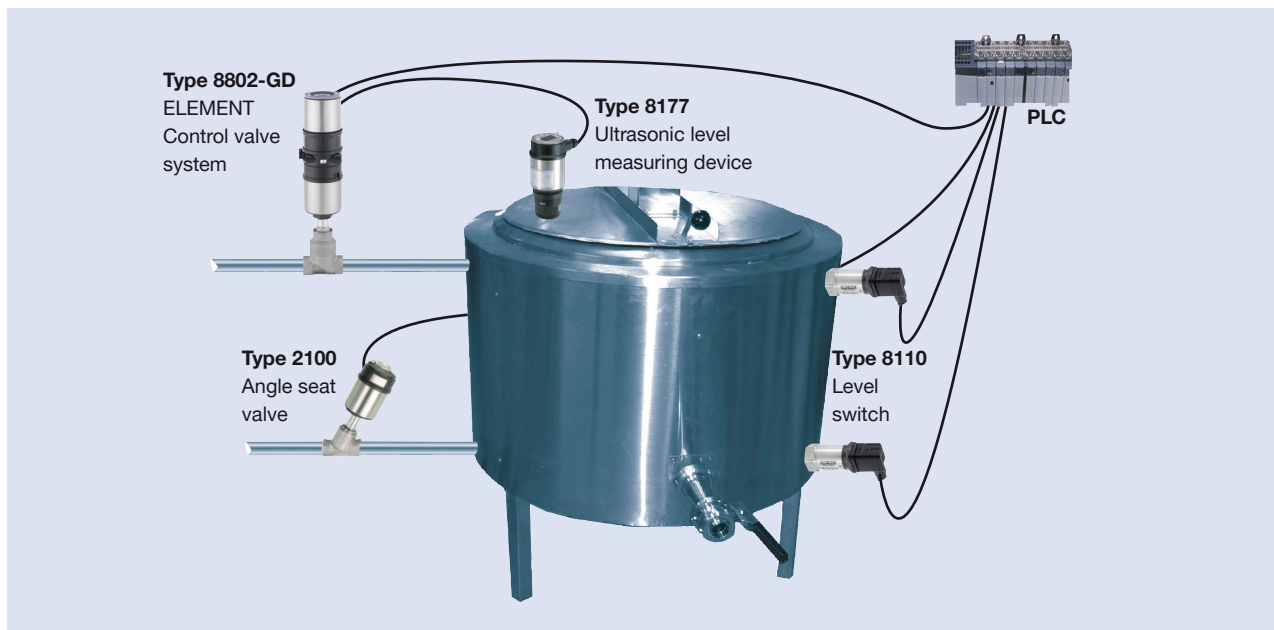

To find your nearest Bürkert facility, click on the orange box →

[www.burkert.com](http://www.burkert.com)

In case of special application conditions,  
please consult for advice.

Subject to alteration.  
© Christian Bürkert GmbH & Co. KG

1806/11\_EU-en\_00895005